

Eliza S (A150)

User Guide English



Table of contents

1. Read first: Safety information.....	2
2. Important information	4
3. Package contents.....	5
4. Description of functions.....	6
5. Overview.....	8
6. Installation	11
7. Communication path.....	14
8. Pairing	15
9. Radio trigger.....	17
10. General information	18
11. Maintenance	18
12. Technical data.....	19
13. Others.....	22

1. Read first: Safety information



Always read and follow the safety information accompanied by this symbol.

- Always test the system according to the instructions before use and always test the product after adjustments have been made.
- The device is not always suitable for all users and should not be seen as a substitute for the caregiver's monitoring routines.
- The device are NOT intended for life-sustaining equipment, where any technical failure may result in serious injury or death.

- Check the unit regularly and replace if necessary.
- User's should pay particular attention to the potential for interference from other systems operating in the same or adjacent radio frequency bands.
- The compartment covers may be opened only by authorised persons in accordance with the instructions in the service manual.
- Battery replacement may be performed only by authorised persons in accordance with the instructions in the Maintenance section. Only use recommended battery type as stated in the Technical Data section.



CAUTION

Only use batteries, power supply and accessories that have been approved for use with this particular model. Connecting other accessories may be dangerous and may invalidate the type approval and guarantee.

- Only use recommended power supply as stated in the Technical Data section.
- The power supply can be used as a disconnecting device. The wall socket shall be installed near the equipment and shall be easily accessible.

IMPORTANT!

This device use radio signals, the mobile phone network and the terrestrial network. This means that connection cannot be guaranteed in all circumstances.

1.1. Medical units

The use of equipment that transmits radio signals as a social alarm, can interfere with insufficiently protected medical equipment. Consult a doctor or the manufacturer of the equipment to determine if it has adequate protection against external radio signals, or if you have any questions.

To avoid potential interference, manufacturers of implanted medical devices recommend a minimum separation of 15 cm between a wireless device and the medical device.

If you have any reason to suspect that interference is taking place, turn off the device immediately. If you have any questions about using your wireless device with an implanted medical device, consult your health care provider.

2. Important information

All systems using radio and network communication are subject to interference beyond the user's control.

Products from Careium are designed to minimise the impact of such interference.

Nevertheless, the user must be aware that system components can be subjected to interference or other influences that may cause malfunction.

It is therefore important to regularly check that every part of the system works in all areas, especially radio communications. Contact your supplier immediately in case of any suspected malfunction.

Users should pay particular attention to the risk of disruption from products which communicate using the same or adjacent radio frequency bands.

For further information, please contact your supplier or refer to the service manual or the documentation at www.careium.com/support/.

The device has a rechargeable battery that enables the device to be operated even in the event of a power failure. The device will beep for a short while after power failure. The alarm receiving centre will be notified in the event of power failure as well as low charge level. When the battery reaches a low charge level, this is indicated by a blinking status light, *see 5.3. Indicator lights on p. 10*. The backup battery power supply secures the operation up to 72 hours.

3. Package contents

- Eliza S
- Power supply
- Radio trigger with accessories
- User guide/Quick start guide

4. Description of functions

Eliza S is a digital social alarm and smartcare hub.

Adaptable for future needs and connects to a wide range of accessories and welfare services – enabling the user a tailor made solution.

Eliza S allow the user to call for assistance if they have an accident or a fall at home. Eliza S can potentially be a life-saving device if someone has a fall or some other accident when they are alone.

Eliza S has a built in module for 2G, 3G and 4G mobile networks, the unit has possibility to transfer alarms over mobile telephone networks. The unit offers the user the possibility of two way handsfree voice communication, even if the users is far away from the Eliza S, using existing standard for VoIP (Voice over Internet Protocol) calling. The unit uses SIP, a standard protocol to initiate speech and video over digital connections. In addition to voice connected alarm calls, Eliza S offers a platform for transfer of detailed alarm information, speech messages, online status etc.

The Eliza S is assigned an unique identification number (ID) that is transferred and corresponding to personal information stored in the alarm receiving centre (ARC).

The radio trigger is adapted for use with the unit,
see 9. Radio trigger on p. 17.

4.1. Activate the alarm

The assistance alarm can be activated:

- by pressing the button on a radio trigger.
- by pressing the integral alarm button on the Eliza S.

On activation, the Eliza S calls an alarm receiver to summon help.

4.2. Alarm transmitters

50 radio transmitters (triggers/sensors) can be programmed with the Eliza S, e.g. a radio trigger. In the event of an alarm from a radio transmitter, the battery status of the radio transmitter is tested.

4.3. Alarm receivers

Up to 10 alarm receivers can be programmed. The alarm is identified using an alarm code which is programmed into the Eliza S.

The person receiving the alarm can then speak directly with the person raising the alarm and take appropriate action.

4.4. Other functions

Additional functions can be activated or modified – refer to the service manual or contact your supplier for further information.

5. Overview

5.1. Back view

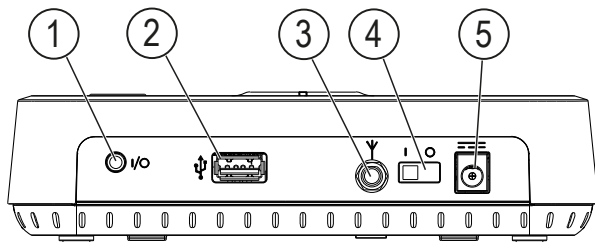



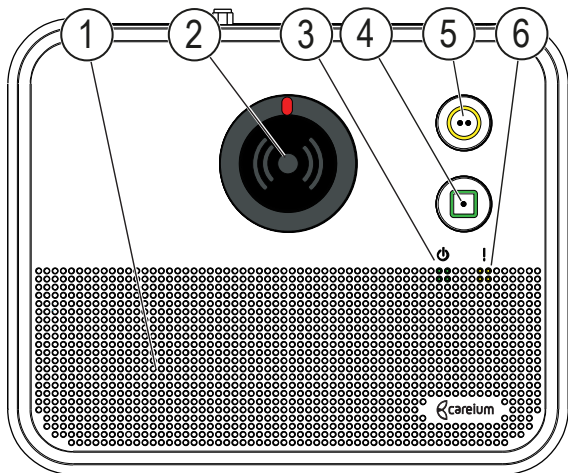

- | | |
|-------------------------------|---|
| 1. I/O connector | 3.5 mm audio out or wired input |
| 2. USB-port (optional) | For USB expansion |
| 3. External antenna connector | For an external antenna that must be adapted for use with Eliza S |
| 4. Power switch | Turns Eliza S on or off |
| 5. Power supply socket | 9V, 2A |

5.2. Top view



- | | |
|-----------------------|-----------------------------|
| 1. Loudspeaker | 4. Square button (green) |
| 2. Alarm button (red) | 5. Circular button (yellow) |
| 3. Power indicator | 6. Status indicator |

5.3. Indicator lights

2		ALARM	RED
		Steady light	Normal operation
		Blinking light	Alarm activated
3		ON	GREEN
		Steady light	Mains power
		Blinking light	Mains failure
4		SQUARE	GREEN
			Press to cancel an alarm
5		CIRCLE	YELLOW
6		STATUS	YELLOW
		Off	Normal operation
		Steady light	Network problem
		Blinking light	Low battery

6. Installation

6.1. Remove top cover



CAUTION

Only authorised persons may open the cover. Turn off the device and disconnect the external power supply before removing the cover.

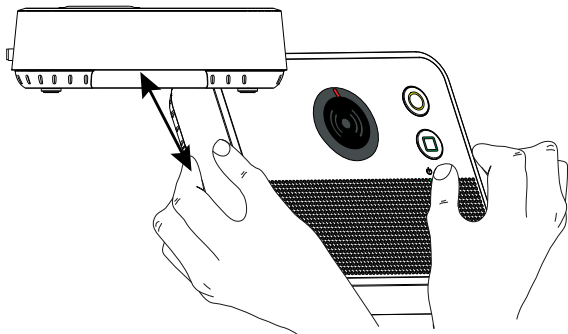

- Ensure that Eliza S is switched off.
- Place your fingers of both hands in the grooves on the sides of Eliza S and gently pull outwards and upwards on the top cover.



IMPORTANT

Do not bend or twist the cover excessively as it may get damaged.

6.2. Inside view

Illustration below is shown with the top cover removed.

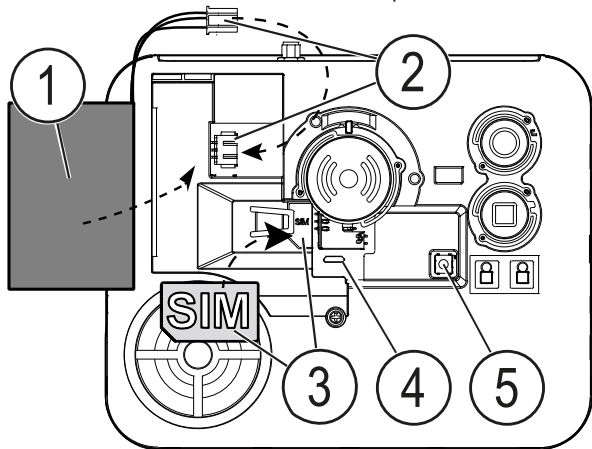

1. Battery
2. Battery connector
3. SIM card slot
4. Maintenance USB-port
5. Service menu button

6.3. Install the SIM card



IMPORTANT

Turn off the device and disconnect the external power supply before removing the cabinet.

- Carefully move the battery aside to expose the SIM card holder. If the battery already is installed, please note if the battery is connected to not damage the wiring.
- Install the SIM card according to picture , note the markings.

- Replace or install the battery.



IMPORTANT

Always make sure the battery is connected if the device is new or has been stored.

- Replace the cover and gently push in into place. Listen for the clicks that tells you that the cover is in place.



CAUTION

1234 or 0000 are not appropriate PIN codes for the SIM card, if any of these PIN codes are used, the code should be changed before installation. Change of PIN code is preferably done using a mobile phone.

6.4. Connection

Eliza S is easy to install:

1. Connect the power supply to the wall socket and the power supply lead to the DC input socket. Keep the device connected to the mains power at all times.
2. Turn the power switch to the **I** position
3. Check that the **on**  indicator lamp has a steady red light
4. The status light shall go off within 90 seconds if the mobile network (GSM/UMTS/LTE) is detected
5. Carry out a test alarm from the Eliza S



CAUTION

Installation must be performed only by authorised persons in accordance with the instructions in the service manual.

7. Communication path

Example of a simplified communication path

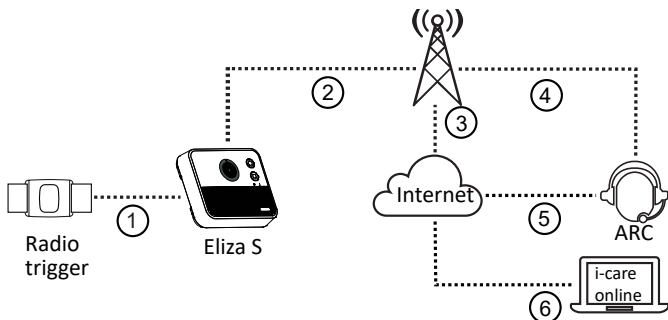

1. Radio or wired alarm trigger activated.
2. Connection via mobile network (GSM/UMTS/LTE) to Voice, IP alarm protocol and additional data
3. IP connection via mobile network (GSM/UMTS/LTE)
4. Voice connection via mobile network (GSM/UMTS/LTE)
5. IP connection to a digital Alarm Receiving Centre (ARC)
6. Optional connection to i-care® online device management system.



8. Pairing

Contacts, alarm codes and settings are programmed using www.icareonline.com or by using a computer via a web-browser.

In some cases, the Eliza S can be delivered pre-programmed by the supplier. For help with pairing, please refer to the service manual or contact your supplier.

8.1. Pairing radio triggers

Up to 50 radio triggers/sensors or other radio-alarm transmitters can be paired to Eliza S.

- Press and hold the Green square button  for 4 seconds and release when an audible signal is played and the Power indicator  starts to blink.
- Activate the radio transmitter. When Eliza S receives the radio signal an audible signal is played.
- Confirm the pairing by pressing and releasing the red integral alarm button once on Eliza S. The successful pairing is confirmed with an audible signal.
- The radio trigger is now paired and set to a default alarm type. The alarm type can be changed anytime using the optional i-care® online service.

Note: Repeat the steps above to pair additional radio triggers.

8.2. Check the radio coverage

Always check the function after installation and pairing.

- Press and the Green square button  for 4 seconds.
- Press/activate the radio trigger/accessory. When Eliza S receives the radio signal, you will hear a tone. Repeat this in all areas where the radio trigger/accessory shall function.





8.3. Check the mobile network signal strength

When installing the Eliza S, the mobile network signal strength must be verified.

The mobile network signal strength can be checked via www.icareonline.com or by using a local computer via any web browser. For more information, see the service manual.

8.3.1. On device check

Check the mobile network signal strength on the device.

1. Remove compartment top cover of the device to access the Service menu button.
2. Press the Service menu button,
see 6.2. Inside view on p. 12.
3. A synthetic voice will say, **-Service Mode!**
4. Press the Green square  button repeatedly until a synthetic voice will say, **-Signal strength!**
5. Press the Main Integral alarm button  once.
6. The actual signal strength will be presented via a synthetic voice.
7. Press the Green square  button repeatedly until a synthetic voice will say, **-Exit!**
8. Press the Main Integral alarm button  once.
9. Replace the compartment cover.

Note! *If acceptable value can't be achieved an external antenna must be used.*

8.4. Check the functionality

Always check the function after installation and pairing. Test alarms shall be done regularly and in a way that secures the whole alarm chain from radio transmitter to alarm receiver.

8.5. Automatic test

The functionality of the Eliza S and its communication can automatically be checked down to every other minute through the optional i-care[®] online service. It can also be checked by automatic function monitoring or a periodical test report to the Alarm receiving centre (ARC), for example once a day or once a week.

9. Radio trigger

The radio trigger uses two-way radio communication, this means that when Eliza S receives an alarm from a radio trigger the carephone will send a confirmation of receipt to the radio trigger. This is confirmed on the radio trigger by indicator light change from red to green. If the radio trigger doesn't get any confirmation, the alarm is repeated.

The radio trigger can be worn using a wristband or neckband.

The radio trigger is waterproof according to IP67 by an integrated gasket and can be carried in the shower and in wet environment.

10. General information

- Verification of mobile network coverage should always be done as a part of installation.
- In order for an alarm to be sent, at least one alarm receiver/response centre needs to be programmed.
- The Eliza S must not come into contact with water or any other liquid.
- Used batteries shall be disposed of in an environmentally-responsible manner.
- Eliza S need to be equipped with a mini-SIM (2FF) and having an appropriate mobile subscription including voice and data.

11. Maintenance

11.1. Cleaning

The Eliza S and the radio trigger should be cleaned using a slightly damp cloth.

Do not use other solvents when cleaning.

Note! *By ordering a complete housing set you can upgrade your used radio trigger to look as brand new.*

11.2. Reinstatement

If the Eliza S is reinstated at a new user, it shall be reset to default settings and re-programmed according to the data and requirements of the new user.

11.3. Replace the battery

Battery should be replaced within three years, or a.s.a.p after battery alarm that is not related to a power cut. It's normal that a long-term power cut generates a battery alarm.

11.4. Replace the radio trigger battery

To replace the radio trigger's battery, please refer to the service manual or contact your supplier.



CAUTION

Battery replacement may be performed only by authorised persons in accordance with the instructions in service manual.

12. Technical data

12.1. Carephone Eliza S

Model no:	A150
Dimensions:	170 x 138 x 43 mm (L x W x D)
Weight incl. power supply and cables:	0.6 kg
Power supply:	9 VDC power supply
Power consumption:	2W (Nominal)
Backup battery:	3.7 V, 2000 mAh, Li-Ion
Backup time:	Up to 72 hours (new and fully charged battery)
Inputs:	1 Normally Open (NO)
Output:	Audio

Communication:	GSM 2G, UMTS/HSDPA 3G, LTE 4G, Wi-Fi (optional with USB-version)
Radio frequency band:	869,2-869,25 MHz
Number of radio transmitters:	Up to 50
Equipment class:	Class 1 radio equipment <i>Class 1</i>

12.2. Mobile networks

(MHz) [maximum radio-frequency power/dBm]

Network bands:

2G GSM	(900) [33], (1800) [30]
3G UMTS	1 (2100) [24], 8 (900) [24]
4G LTE FDD	1 (2100) [24], 3 (1800) [24], 7 (2600) [24], 8 (900) [24], 20 (800) [24], 28 (700) [24]
SIM card interface:	1,8V and 3V mini-SIM (2FF)

12.3. Other radio

(MHz) [maximum radio-frequency power/dBm]

SRD:	(869.200-869.250) [10]
Bluetooth, version:	5, BLE , long range (2402 - 2480) [10]
ZigBee:	IEEE 802.15.4 (868.0 - 868.6) [20], (2400 - 2483.5) [20]

13. Others

13.1. EU Declaration of conformity

Hereby, Careium declares that the radio equipment type A150 and 9150 is in compliance with Directives: 2014/53/EU and 2011/65/EU.

The full text of the EU declaration of conformity is available at the following internet address: www.careium.com/dofc.

13.2. Ecodesign declaration, energy efficiency for external power supply

Hereby, Careium declares the external power supply for this device is in compliance with Commission Regulation (EU) 2019/1782 regarding ecodesign requirements for external power supplies pursuant to Directive 2009/125/EC. The full information regarding the ecodesign requirements is available at the following internet address: www.careium.com/ecodesign

13.3. Environmental information

This product complies with the requirements of the EU directives, 2012/19/EU (WEEE) and 2006/66/EC (batteries). These directives regulate the product liability for electrical and battery recycling with the purpose of increasing recycling and minimising waste. The unit is marked with the crossed out wheeled bin logo, which indicates that it shall be handed in for recycling. The product can be returned free of charge to a recycling station that is connected, directly or via a recycling system, to Careium or to your distributor. For detailed instructions, please check with your distributor or visit our website, www.careium.com.



Note! *The WEEE information and recycling instructions applies to European Union member states only. For other countries please check local legislation or contact your distributor. Manufactured in accordance with the EU directive, 2011/65/EU (RoHS2). The materials used in the radio trigger wristband and neckband meet the textile safety requirements of Oeko-Tex standard 100.*

13.4. Legal notices

The information contained here is subject to change without notice. The only warranties for Careium products and services are set forth in the express warranty statements accompanying such products and services. Nothing herein should be construed as constituting an additional warranty.

Careium shall not be liable for technical or editorial errors or omissions contained herein.

13.5. UK Declaration of Conformity

Hereby, Careium declares that the radio equipment type A150 and 9150 is in compliance with the relevant UK legislation.

The full text of the UK declaration of conformity is available at the following internet address: www.careium.com/dofc

A150 (Eliza S)

English

Manual_Careium_Eliza_S_A150_100x148_en_v10

©2021 Careium AB. All rights reserved.

www.careium.com

